

STARTTIME III



3399.504.02
Version 1.1
Edition August 2009

CAUTION

- ❑ **Never use any other charger than the supplied or a type approved by Swiss Timing. This could destroy the battery, cause damage to unit, and possible cause personal injury due to fire or/and electrical shock.**
- ❑ **Lead/Acid batteries may be damaged if discharged, and left unused over a period of time. To avoid this, keep the charger connected at all time during storage. This will assure that the battery is always fully charged, and the unit is ready for use.**
- ❑ **Protect the equipment against splashing, rain and excessive sun rays.**
- ❑ **Never use the device if it is damaged or insecure.**
- ❑ **Verify the selection of the power distribution.**
- ❑ **Do not open the case; there is nothing that needs servicing inside it. Nevertheless, if the case must be opened, you must call for some qualified personnel. The power supply cable must be disconnected before opening the case.**
- ❑ **The information contained within this document may be modified without warning.**
- ❑ **Swiss Timing LTD cannot be held responsible for errors within this document nor for any subsequent nor consequential damages (including loss of profit) arising from its provision, nor performance or use of products described herein, which will be covered by another guarantee, contract or other legal document.**
- ❑ **During the transport of all Swiss Timing equipment delivered with a reusable carry case, the said case should be used at all times. This is imperative to limit the damage, such as shocks or vibration that can be caused to the units during transport.**

The same cases should also be used when returning equipment to Swiss Timing for repair. Swiss Timing reserves the right to refuse all guarantees if this condition is not fulfilled.



This symbol indicates that this product should not be disposed with household waste. It has to be returned to a local authorized collection system. By following this procedure you will contribute to the protection of the environment and human health. The recycling of the materials will help to conserve natural resources (valid in the EU member states and in any countries with corresponding legislation).

TABLE OF CONTENTS

1	INTRODUCTION	1
1.1	Concept	1
1.2	Front panel	2
1.3	Microphone.....	2
2	INSTALLATION	3
2.1	Operation.....	3
2.1.1	<i>Stand Alone Operation (ARES)</i>	3
2.1.2	<i>Stand Alone Operation (PowerTime)</i>	3
2.1.3	<i>Independent Operation</i>	4
2.1.4	<i>Volume level</i>	4
2.1.5	<i>Battery level</i>	4
2.2	Cabling the installation	5
2.2.1	<i>External loudspeakers connection</i> ⑦.....	5
2.2.2	<i>Extension cables</i>	6
2.3	Troubleshooting.....	6
3	GETTING STARTED.....	7
3.1	First use.....	7
3.2	Main Menu.....	7
3.3	Set Up menu.....	8
3.3.1	SETUP [1] <i>Sound</i> (Swimming).....	8
3.3.2	SETUP [2] <i>Flash Output</i> (N.O.).....	8
3.3.3	SETUP [3] <i>Start Output</i> (N.C.).....	8
3.3.4	SETUP [4] <i>ARES needed</i> (YES).....	8
3.3.5	SETUP [5] <i>False Allowed</i> (YES).....	8
3.3.6	SETUP [6] <i>False Signals</i> (4).....	9
3.3.7	SETUP [7] <i>Standby</i> (15).....	9
3.3.8	SETUP [8] <i>Power off</i> (90).....	9
3.3.9	<i>Menu Set Up navigation</i>	10
3.4	Diagnostics	11
3.5	Factory Reset	11
3.6	Exit Setup	11
4	ELECTRICAL PROPERTIES.....	12
4.1	Power supply	12
4.2	Connectors pinning.....	12
5	MECHANICAL PROPERTIES.....	13
5.1	Dimensions and weights.....	13
6	OPTIONS.....	13

6.1 Auxiliary flash 13
6.2 External loudspeaker 2850.712 13
6.3 Loudspeakers harness cables 13

1 INTRODUCTION

1.1 Concept

The *StartTime III* is the latest edition of the  **SWISS TIMING** acoustic start systems. You will find the *StartTime III* compact and reliable as both the flash and the loudspeaker are integrated in the same case. It is important to position the *StartTime III* so that deaf athletes see the flash. An additional external flash can also be connected to the *StartTime III* where it is most necessary. The **SPEAKER** output enables one to connect a chain of loudspeakers therefore giving the start signal as close as possible to each athlete. The sound of the start signal must be brought as close as possible to the athlete in order to eliminate delay due to the comparatively slow propagation of sound.

The microphone unit enables one to give the start signal and also amplifies verbal commands; the **SPEAK** button connects/disconnects the internal microphone. The volume of verbal commands can be controlled on the main device. Two luminous indicators show the status of the system:

- **POWER** led indicates if device is switched on
- **READY** led indicates that it is controlled from the timing device.

The system, when connected to timing devices such as the ARES 21, gives a high level of security with the **READY** indicator. That is to say it may be deactivated from the Control Room if the Timing Technician is not ready to accept a start signal.

1.2 Front panel

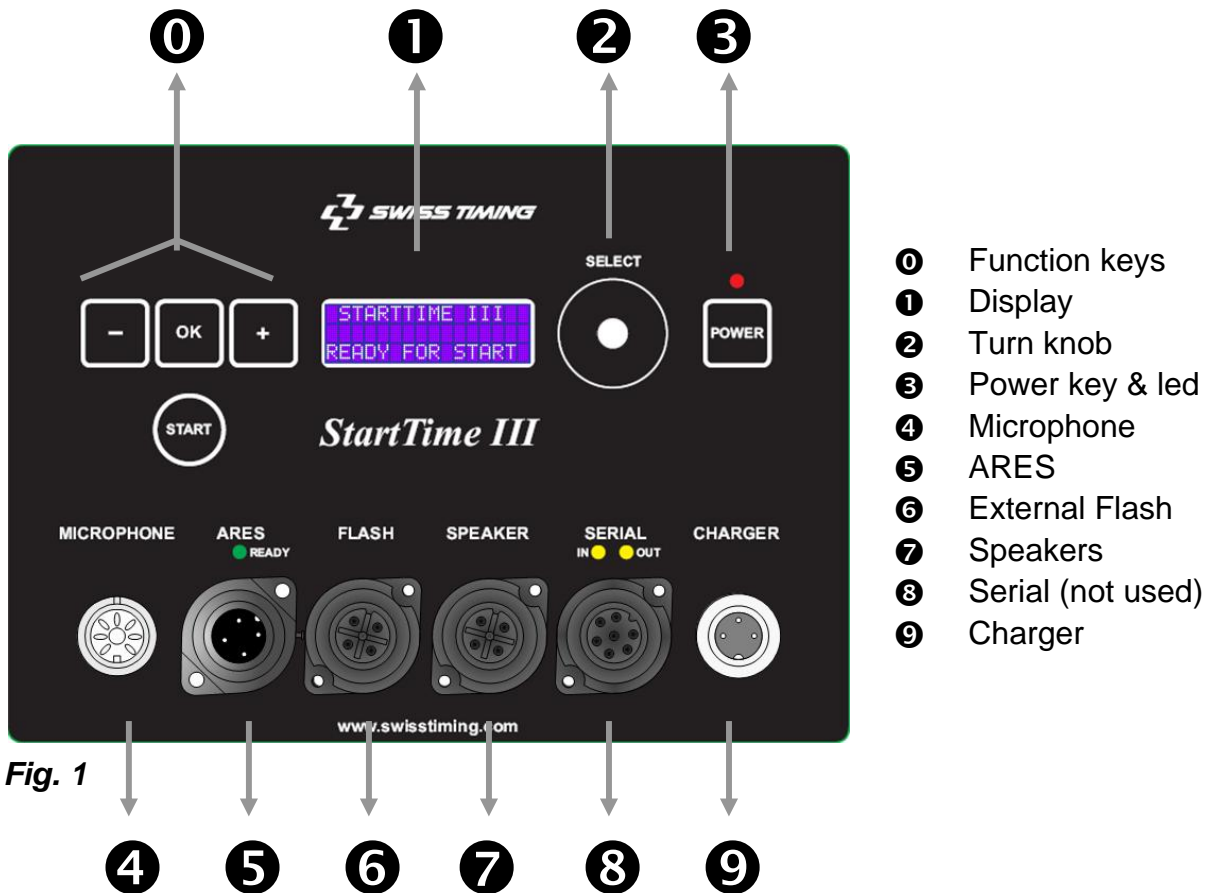

1.3 Microphone

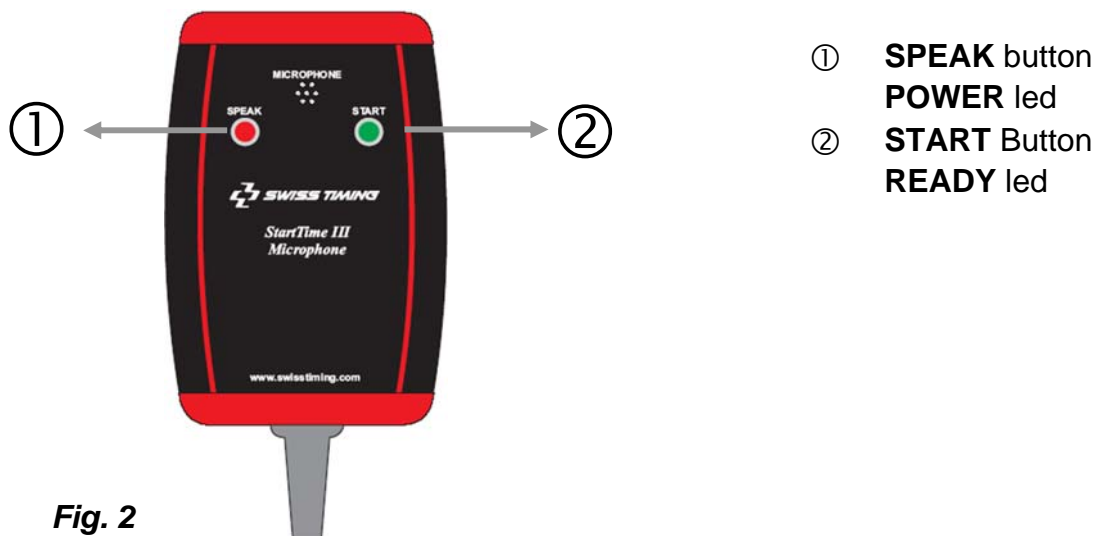

2 INSTALLATION

2.1 Operation

2.1.1 Stand Alone Operation (ARES)

1. Connect the microphone to connector ④.
2. Connect the cable from ARES to connector ⑤.
3. Turn the unit ON by pressing the  key ③.
The power lamp will light up and the red led ① in the microphone should now be lit.
If the ARES is cleared and ready for start, the green led ② would be lit as well.
4. Press the **SPEAK** button ①. Adjust the volume button on the *StartTime III* unit to an appropriate level.
5. Check if **READY** signal green led ② is on.
6. Press the **START** button ②.
7. One signal should sound from the loudspeakers, and the ARES should be activated.

If a false start is to be announced, press the **START** button ② again within 10 seconds and several signals will be heard (Depending on **SETUP [5]** and **SETUP [6]** selection).

The level of the start / false start signal can be adjusted on the main unit.

Notes:

The unit cannot be started, if **SETUP [4]** is selected to **YES**, and the ARES/OSM6 is not cleared. In this case, the system will always announce a false start.
The false start signal is only functional if **SETUP [5]** is selected to **YES**.



2.1.2 Stand Alone Operation (PowerTime)

1. Set **SETUP [4]** to **NO** (**First use only**).
2. Connect the microphone to connector ④.
3. Connect the cable from PowerTime to connector ⑤.
4. Turn the unit ON by pressing the  key ③.
5. Press the **SPEAK** button ①. Adjust the volume button on the *StartTime III* unit to an appropriate level.
6. When the contenders are ready, start the heat by pressing the **START** ② button.
If a false start is to be announced, press the **START** button ② again within 10 seconds and several signals will be heard (Depending on **SETUP [5]** and **SETUP [6]** selection). After 10 seconds, the system will be ready for a new start.

The actual procedure may vary following software version, but the general function is the same.



2.1.3 Independent Operation

It is possible to use the *StartTime III* without the microphone unit. In this case, it is only possible to carry out starts and false starts with the "START" button of the *StartTime III*.

1. Turn the unit ON by pressing the  button ③.
2. Press the  key ① for the start.
The start signal can only be given once the **READY** led ⑤ is on or if **SETUP [4]** is selected to **NO**.
3. If a false start is to be announced, press the  key ① again within 10 seconds and several signals will be heard (Depending on **SETUP [5]** and **SETUP [6]** selection). After 10 seconds, the system will be ready for a new start.





2.1.4 Volume level

With microphone:





- Maintain the **SPEAK** button ① pressed and turn the  knob button ② to the desired level.
- Maintain the **START** button ② pressed and turn the  knob button ② to the desired level.

Without microphone:

From the race display,

- Press  key ①, **SPEAK** Volume is displayed and turn the  knob button ② to the desired level.
- Press  key ①, **START** Signal is displayed and turn the  knob button ② to the desired level.

2.1.5 Battery level

	Battery is full charged.
	Battery is half charged.
	Battery is empty, connect the charger as soon as possible.
	Battery is empty, connect the charger urgently.

2.2 Cabling the installation

2.2.1 External loudspeakers connection

The minimum recommended load per amplifier is 3.2 Ohms and the maximum load per amplifier is 16 Ohms. It is possible to use a load of 2 Ohms, but will result in increased distortion and loss of output power. Any combination that gives a total load of between 3.2 and 16 Ohms is acceptable. Note the phase (+ sign or Red dot) of the speakers, or loss of sound quality will occur.

Note: never connect the two speaker outputs together in any way or connect them to ground. This may cause severe damage to the amplifiers.

Examples of loudspeaker connection:

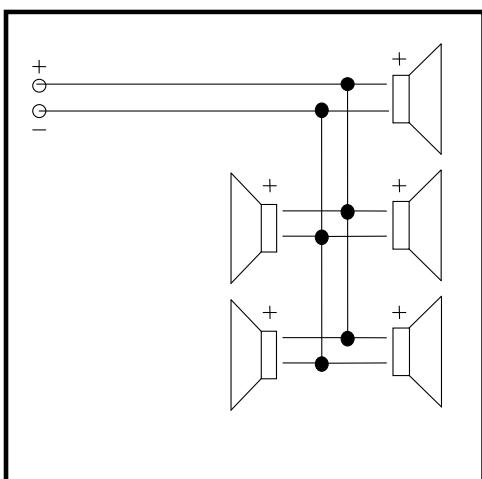

5 Speakers of 16 Ohms each
Total load of 3.2 Ohms

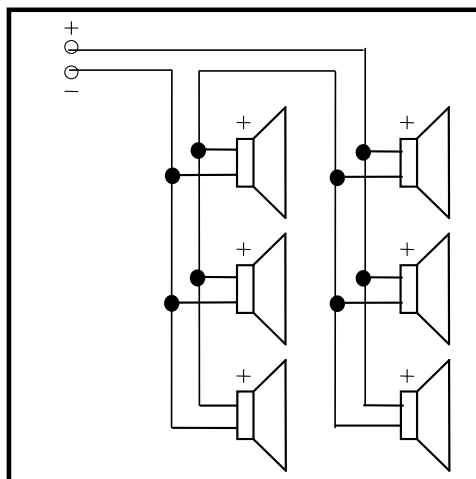

6 Speakers of 16 (8) Ohms
Total load of 10.6 (5.3) Ohms

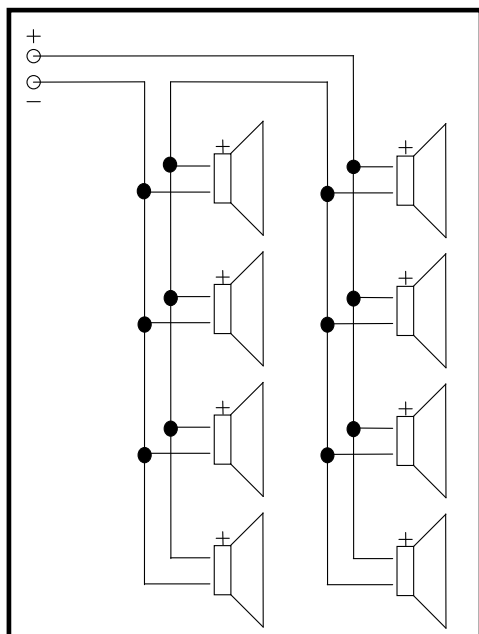

8 Speakers of 16 (8) Ohms each
Total Load of 8 (4) Ohms

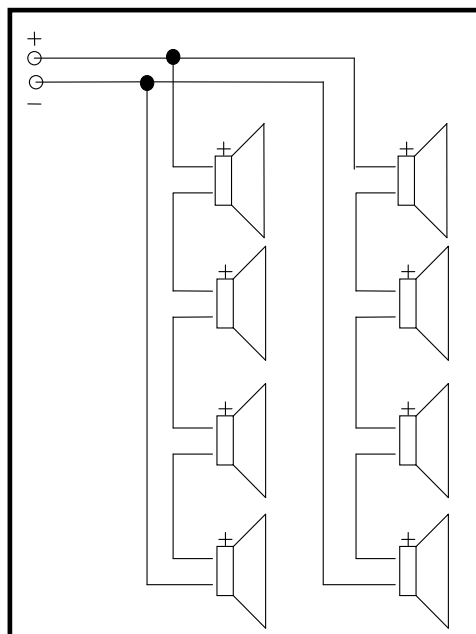

8 Speakers of 4 (8) Ohms each
Total Load of 8 (16) Ohms

2.2.2 Extension cables

The **microphone cable** may be extended to 30 Meters. If extended further, noise and "hum" may distort the signal. No damage to the unit will happen although.

The **loudspeaker cables** can be extended up to 30 meters with 0.75mm² cable or 50 meters with 1 or 1.5mm² cable. If extended further, loss of sound quality may occur, but no damage will be caused. Beware of polarity of speakers, or loss of sound quality will result.

See also chapter 6.3 Loudspeakers harness cables.

2.3 Troubleshooting

There are three Car type fuses and one fuse 5x20 mm in the unit:

- F1** = 1 AT slow. (Logic and microphone / Car type)
- F2** = 5 AT slow. (Amplifier + Flash power out / Car type)
- F3** = 2 AT slow. (Charger input / Car type)
- F4** = 6.3 Ah slow. (Located on battery cable / 5x20mm)

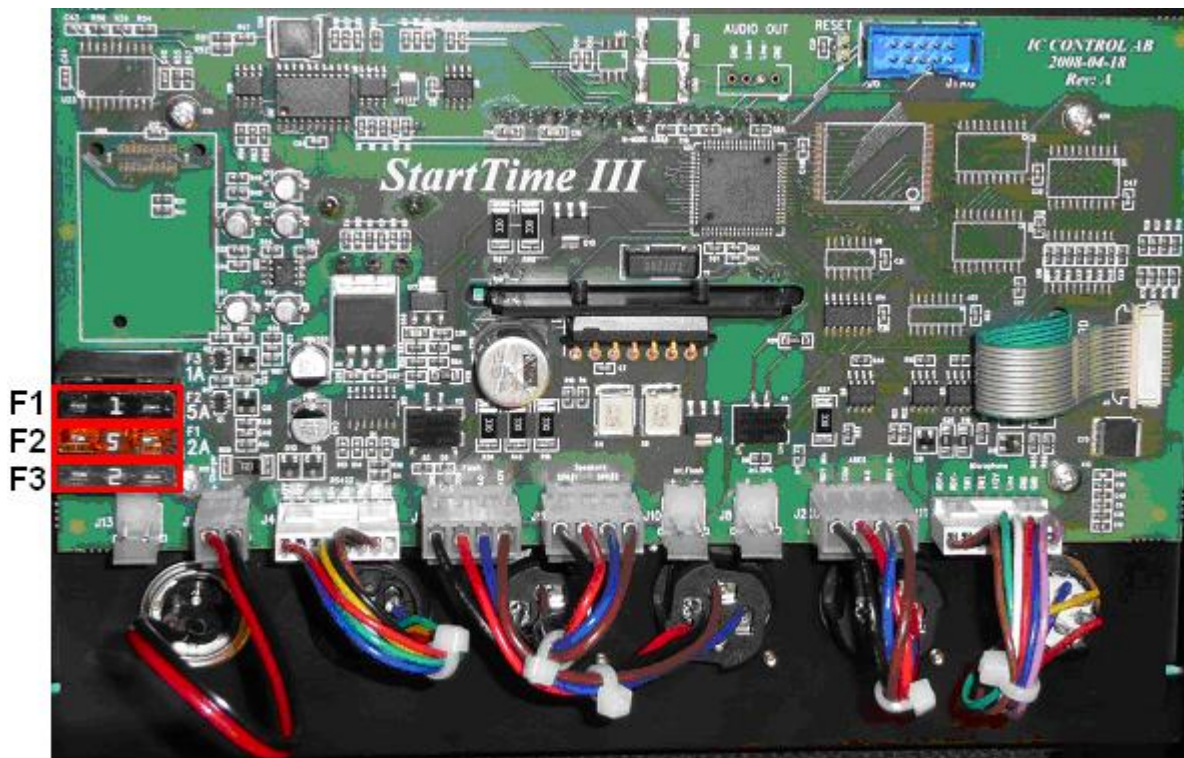

3 GETTING STARTED

3.1 First use

Read chapter 3 and select desired configuration. Connect the charger in connector ⑨ and charge *StartTime III* battery.

3.2 Main Menu

You can access the Setup, Diagnostics and Factory Reset menus by pressing 

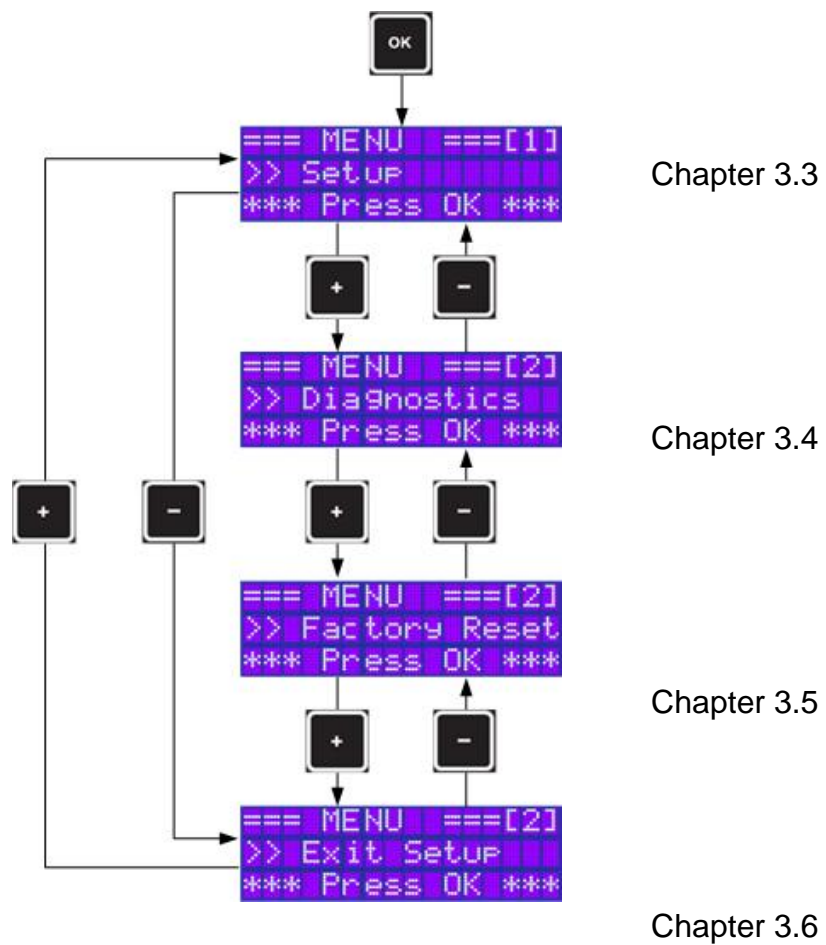

3.3 Set Up menu

Set Up menu allows the user to define particular settings adapted to its own use. To navigate in the menu, use following buttons:



button to enter and exit of the set up menu,



and buttons to move from one to another set up,

SELECT



Turn knob to select value in the set up menu.

Factory settings are shown in brackets.

3.3.1 SETUP [1] Sound (Swimming)

Allows selecting the sound type of Start / False Start signal.

3.3.2 SETUP [2] Flash Output (N.O.)

Select the output contact of the FLASH connector to Normally Open **N.O.** or Normally Closed **N.C.**

3.3.3 SETUP [3] Start Output (N.C.)

Select the output contact of the ARES connector to Normally Open **N.O.** or Normally Closed **N.C.**

3.3.4 SETUP [4] ARES needed (YES)

If you want to authorize the Start from the ARES (control room), select the set up to **YES**. The system, when connected to timing devices such as the ARES 21, gives a high level of security with the **READY** indicator. That is to say it may be deactivated from the Control Room if the Timing Technician is not ready to accept a start signal.

3.3.5 SETUP [5] False Allowed (YES)

If a false start should be announced, select the menu to **YES**. The false start signal is valid during 10 seconds after Start signal.

3.3.6 **SETUP [6]** *False Signals* (4)

Define number (1 - 4) of false start signal generated when a false start is activated.

3.3.7 **SETUP [7]** *Standby* (15)

Value in minutes of automatic Standby if *StartTime III* is not used. The system authorizes a **START** ① in standby mode.

If you do not need this set up, you can select the **Disable** value (power led ③ is blinking).

3.3.8 **SETUP [8]** *Power off* (90)

Value in minutes of automatic Power off if *StartTime III* is not used.

If you do not need this set up, you can select the **Disable** value.

3.3.9 Menu Set Up navigation

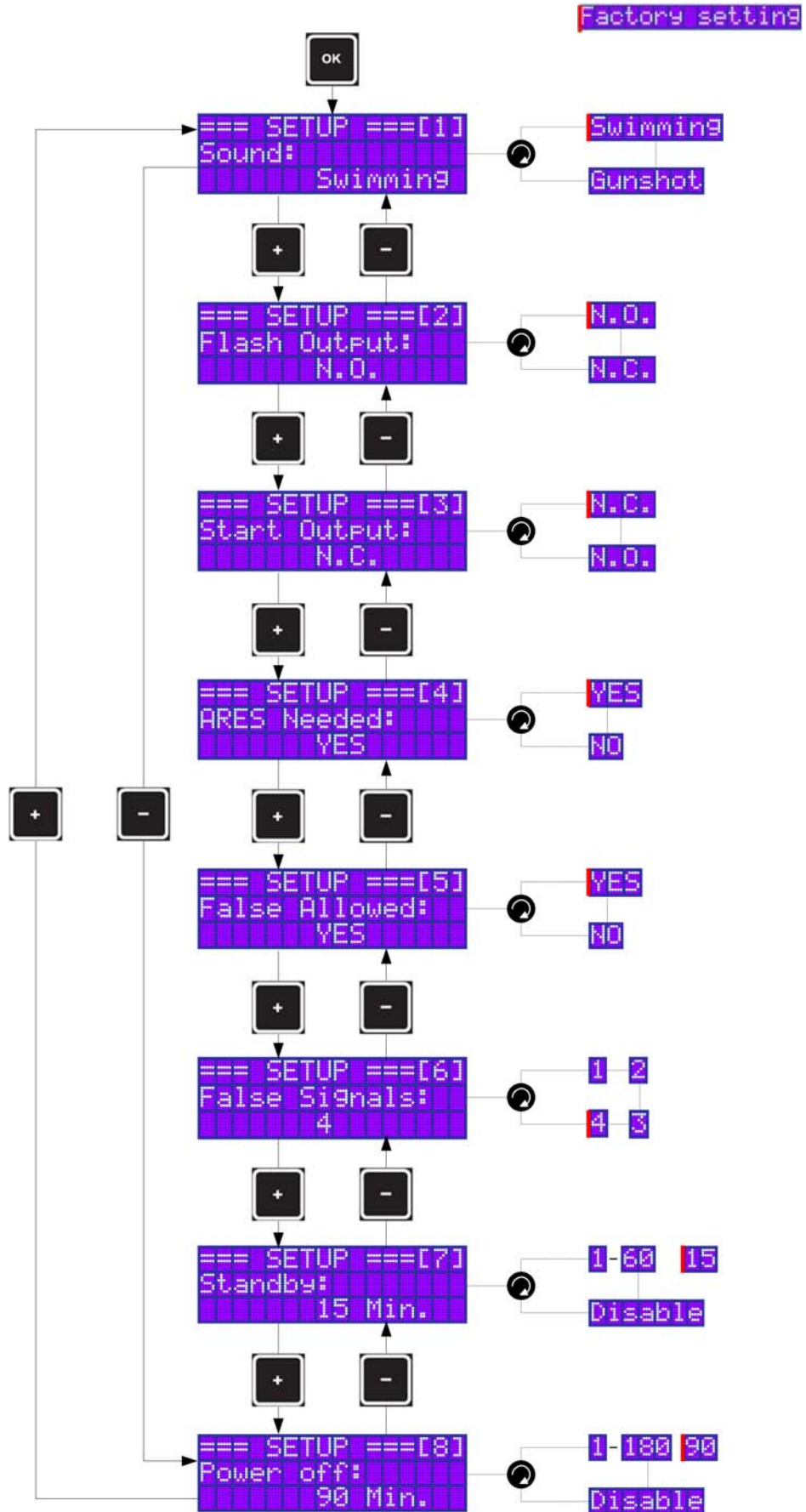

3.4 Diagnostics

The Diagnostics menu allows setting several functions of the Start Time III.

```
=== MENU ===[2]
>> Diagnostics
*** Press OK ***
```

- Sh = Shaftencoder (volume wheel) position.
- Bat = Battery voltage.
- SP = Speak button on microphone.
- ST = Start button on microphone
- AR = Ares Ready input signal.

3.5 Factory Reset

The Factory Reset menu allows the resetting of the factory parameters (see chapter 3.3). Press on OK to confirm.

```
=== MENU ===[2]
>> Factory Reset
*** Press OK ***
```

3.6 Exit Setup

This menu allows exiting the menus.

```
=== MENU ===[2]
>> Exit Setup
*** Press OK ***
```

4 ELECTRICAL PROPERTIES

4.1 Power supply

Use only charger supplied or a type approved by  **SWISS TIMING**. This could destroy the battery, cause damage to unit, and possible cause personal injury due to fire or/and electrical shock.

4.2 Connectors pinning

<i>Description</i>	<i>Connector type</i>	<i>Pin</i>	<i>Pin description</i>
MICROPHONE	DIN 45326 8pFT	1	Line in
		2	Ground
		3	"Talk" – switch
		4	12 Volts (Max 40 mAh)
		5	"Start" – switch.
		6	Ready signal to Green LED (+)
		7	Ready signal to Green LED (-)
		8	Not used
ARES	Tuchel 4pMT	1	Ready signal from ARES (-)
		2	Start to ARES
		3	Start to ARES
		4	Ready signal from ARES (+)
FLASH	Tuchel 4pFT	1	Power feed for Flash (+12V)
		2	Start Out Flash
		3	Start Out Flash
		4	Power feed for Flash (0V)
SPEAKER	Tuchel 4pFT	1	Speaker Plus (+) of Amplifier #1
		2	Speaker Minus (-) of Amplifier #1
		3	Speaker Plus (+) of Amplifier #2
		4	Speaker Minus (-) of Amplifier #2
CHARGER	Tuchel 3pMT	1	Battery (+)
		2	Not used
		3	Battery (-)

5 MECHANICAL PROPERTIES

5.1 Dimensions and weights

Main unit dimensions:	376 x 215 x 195mm w/o Connectors
Microphone dimensions:	118 x 25 x 80 mm. + 7 meter cable
Alarm “low battery”:	Yes, 4 levels indicated as battery symbol (Empty, Low, Medium, Full)
Protection class:	IP41
Power:	Built in 12 Volt / 7 Ah Sealed lead-acid battery
Standby time:	24 Hours (1000 starts). After this, the unit should still be operable for 1 hour. The self-discharge time is approximately 12 months if not in use. An external 12V Lead/Acid battery (car battery) connected to the charger input, could be used if extended operation time is needed.
Charger:	Max. initial current: 1.0 Ah (only for use in dry environment).
Speakers:	Load 3.2 - 16 Ohms
Output speakers:	@13.2 Volts, 3.2 Ohms, 1 kHz Typical: 2 * 13 Watt with < 1 % Distortion Maximum: 2 * 19 Watts with 10 % Distortion
Storage temperature:	-20°C to +65°C
Working temperature:	-10°C to +65°C
Relative humidity:	(20%-80%) without condensation

6 OPTIONS

6.1 Auxiliary flash

Optical signalling device for the start. Connected directly to the *StartTime III*, it can be positioned to one's liking near the deaf athlete.

6.2 External loudspeaker 2850.712

For mobile installations. To be positioned near each starting block so that all swimmers hear the start simultaneously.

6.3 Loudspeakers harness cables

Harness cables 1.5 mm² are used to link the *StartTime III* to the loudspeakers. 3399.9xx where xx = 02 - 10 loudspeakers.

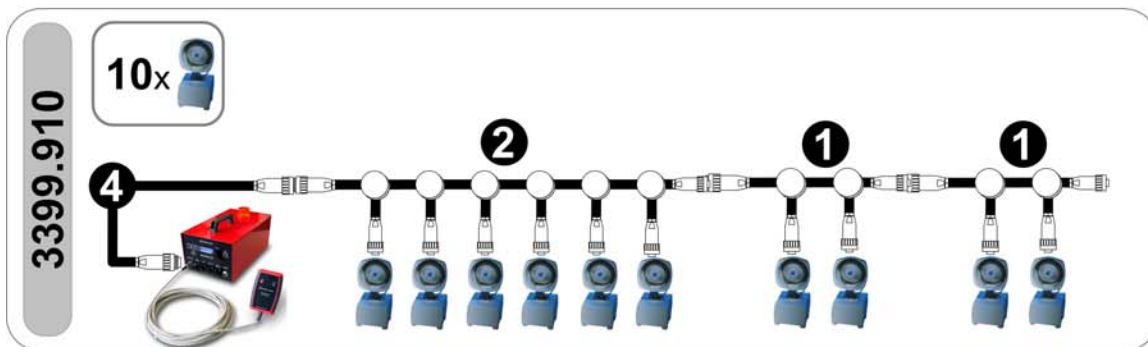
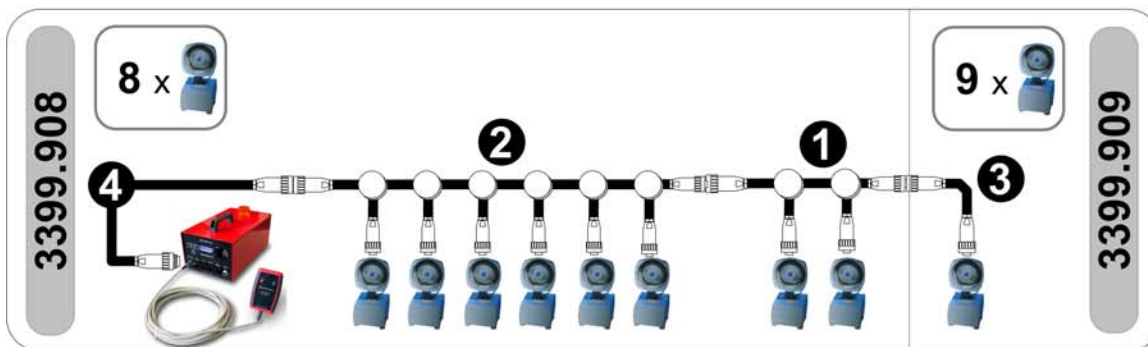
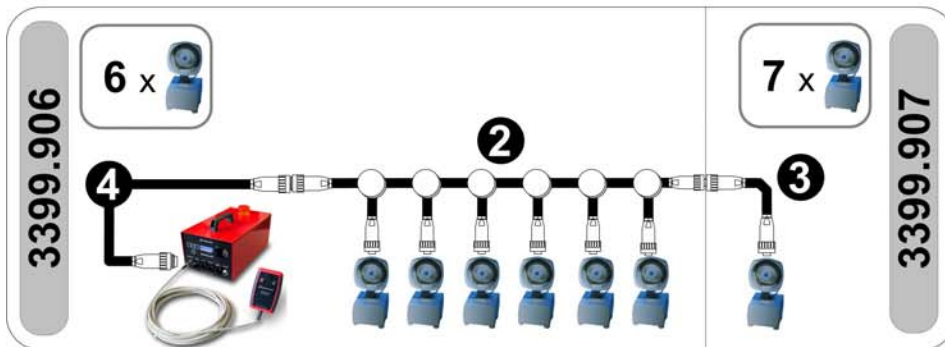
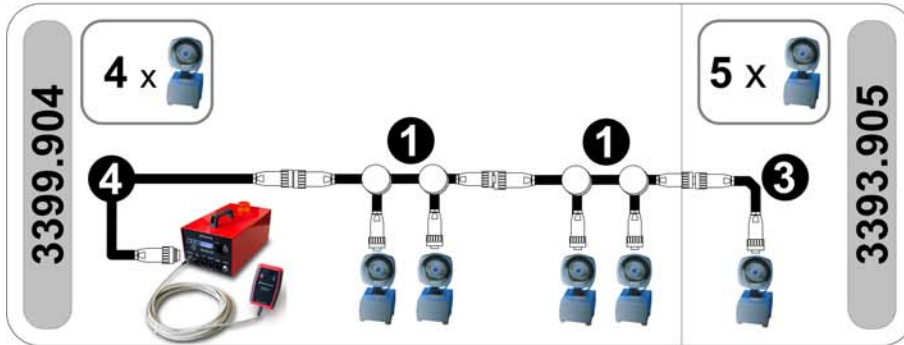
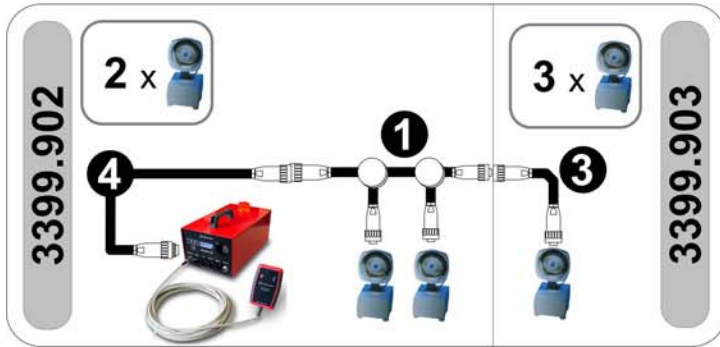

1 3399.620

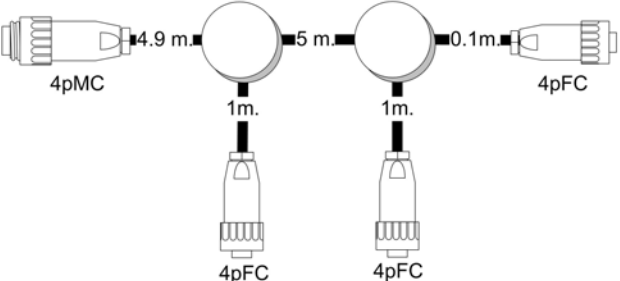

2 3399.621

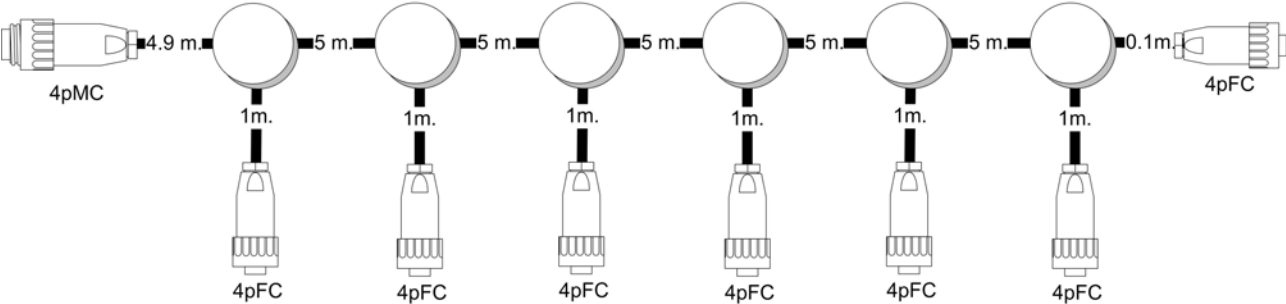

3 3399.630

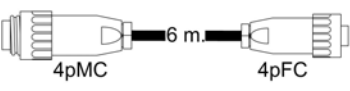

4 3399.631

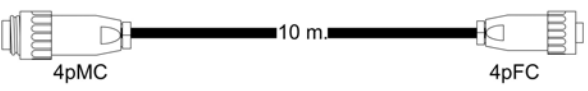

5 3399.632

